



VW Crafter 2017-

Art. 840802

Astmelaua VAN TOUR montaažikomplekt esiuksele | Running boards VAN TOUR for the front door, mounting kit | Боковые пороги VAN TOUR для передней двери, монтажный комплект | Trittbretter VAN TOUR für Vordertür



- | | |
|---|---|
| 1. Kronstein / bracket / кронштейн / Konsole | 1 |
| 2. Kronstein / bracket / кронштейн / Konsole | 1 |
| 3. Plaat / plate / пластина / Platte | 1 |
| 4. Kronstein / bracket / кронштейн / Konsole | 2 |
| 5. Kronstein / bracket / кронштейн / Konsole | 1 |
| 6. T-polt / T-bolt / T-болт / T-bolzen | 1 |
| 7. Lülük / plate with nut / пластина с гайкой / Platte mit mutter | 2 |
| 8. Põlt / bolt / болт / Bolzen M10x30 Wülöck | 7 |
| 9. Põlt / bolt / болт / Bolzen M8x25 | 2 |
| 10. Põlt / bolt / болт / Bolzen M6x100 | 1 |
| 11. Mutter / nut / гайка / Mutter M10 | 7 |
| 12. Mutter / nut / гайка / Mutter M8 | 1 |
| 13. Mutter / nut / гайка / Mutter M6 | 1 |
| 14. Seib / washer / шайба / Scheibe 10,5x20x2 | 7 |
| 15. Seib / washer / шайба / Scheibe 8,4x24x2 | 3 |
| 16. Seib / washer / шайба / Scheibe 6,4x18x1,6 | 2 |
| 17. Vedrusseib / spring washer / пружинная шайба / Federnscheibe A8 | 2 |

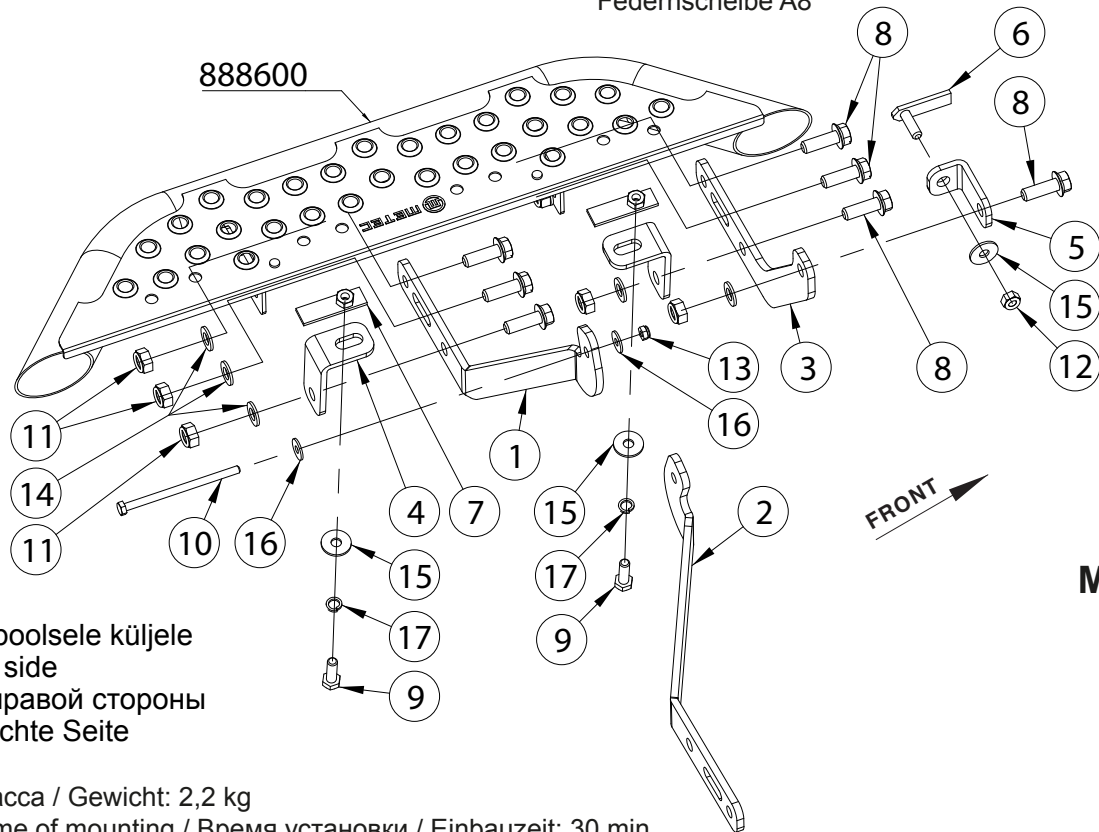

M6 - 11 Nm
M8 - 25 Nm
M10 - 50 Nm

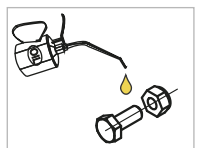

2 - Ainult parempoolsele küljele
Only for right side
Только для правой стороны
Nur für die rechte Seite

Kaal / Weight / Масса / Gewicht: 2,2 kg
Paigaldusaeg / Time of mounting / Время установки / Einbauzeit: 30 min

Vajalikud tööriistad / Required Tools / Необходимые инструменты / Benötigte Werkzeuge

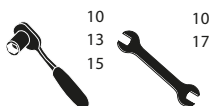

VW Crafter 2017-

Astmelaua VAN TOUR montaažikomplekt esiuksle | Running boards VAN TOUR for the front door, mounting kit | Боковые пороги VAN TOUR для передней двери, монтажный комплект | Trittbretter VAN TOUR für Vordertür

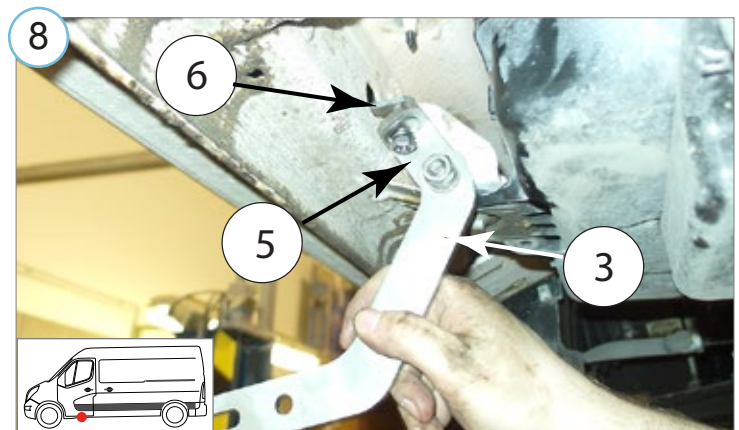
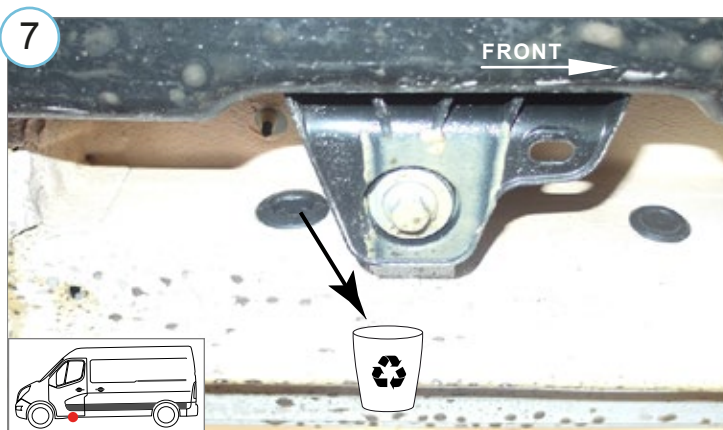
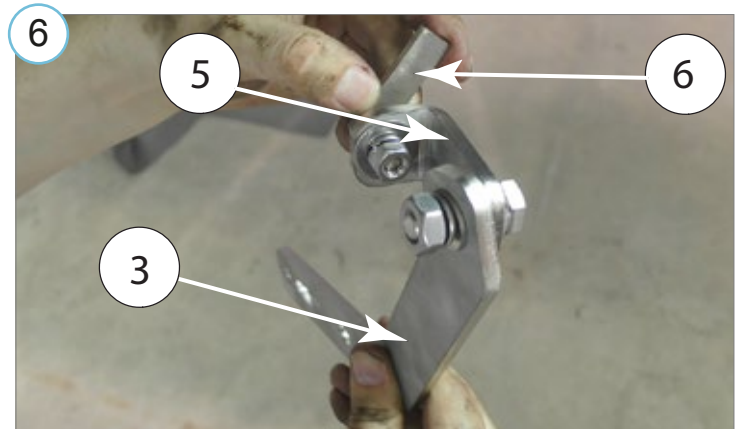
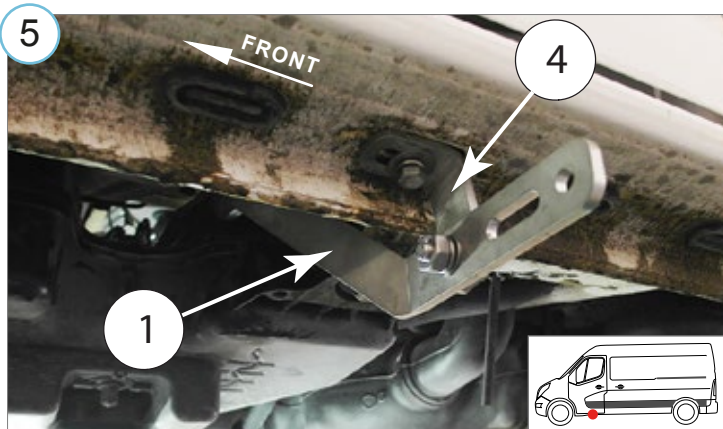
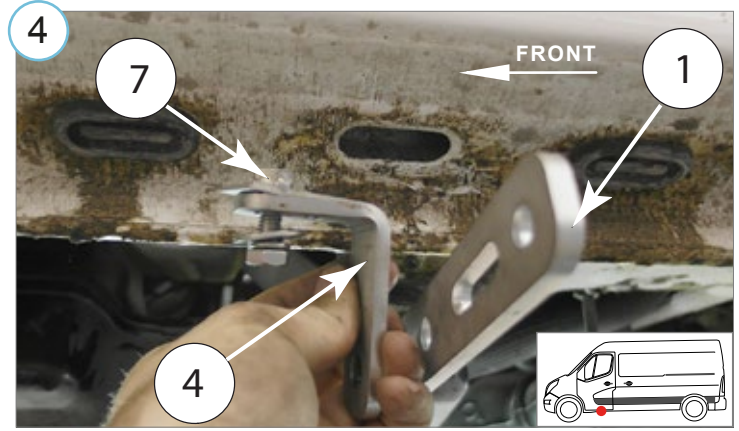
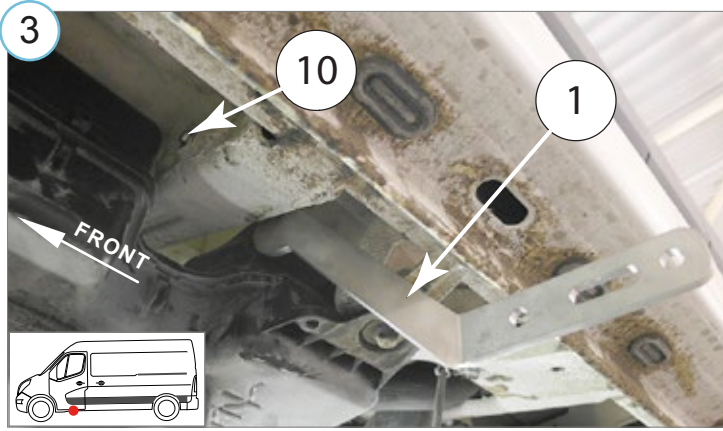
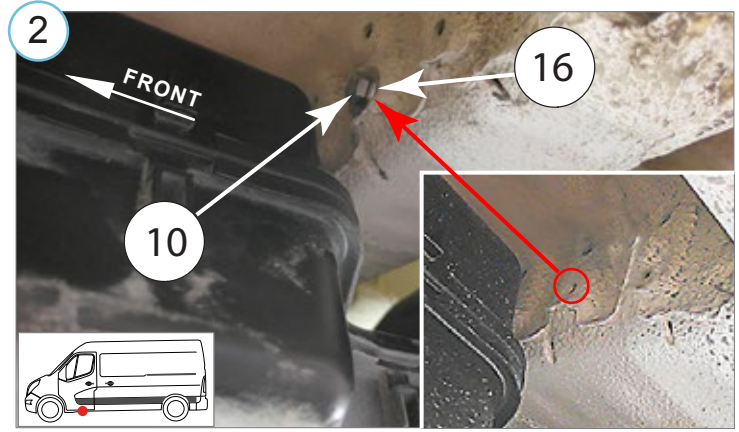
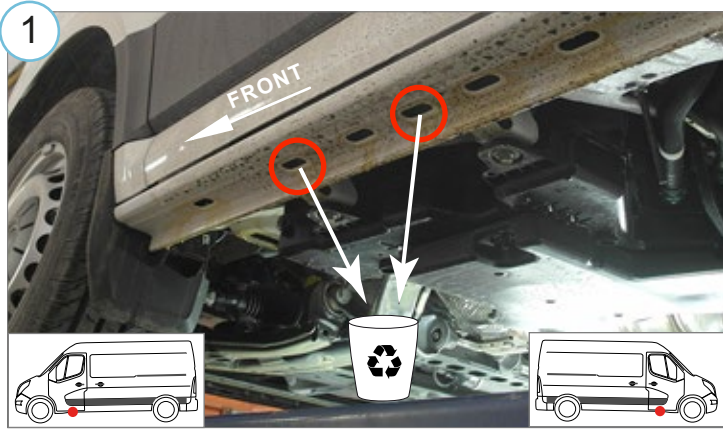

VW Crafter 2017-

Astmelaua VAN TOUR montaažikomplekt esiuksle | Running boards VAN TOUR for the front door, mounting kit | Боковые пороги VAN TOUR для передней двери, монтажный комплект | Trittbretter VAN TOUR für Vordertür

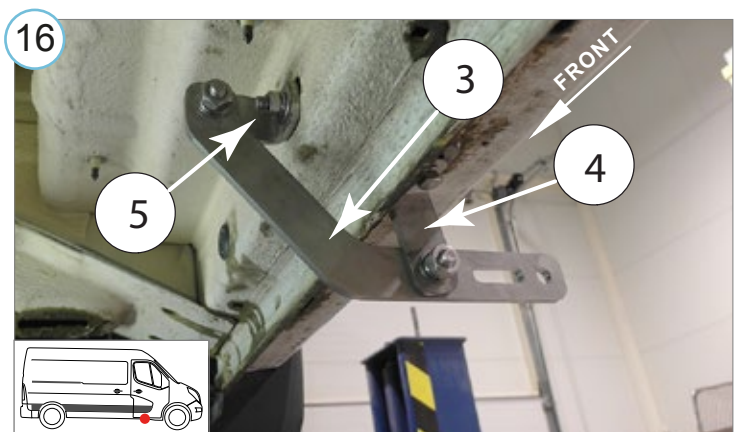
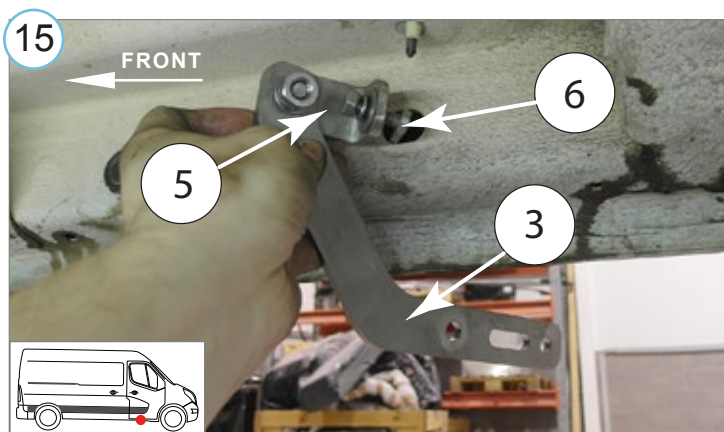
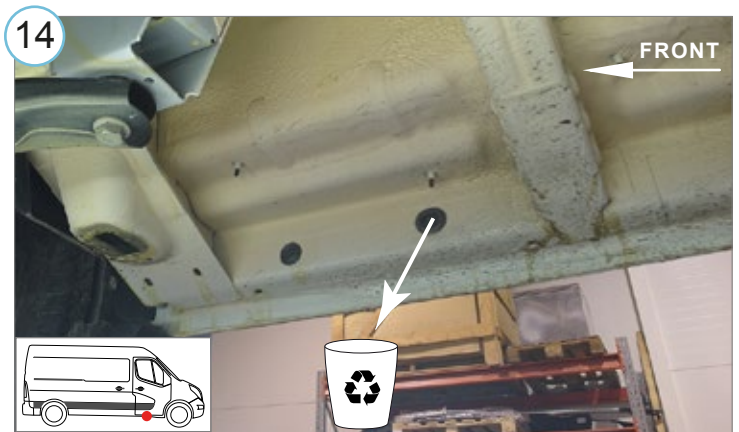
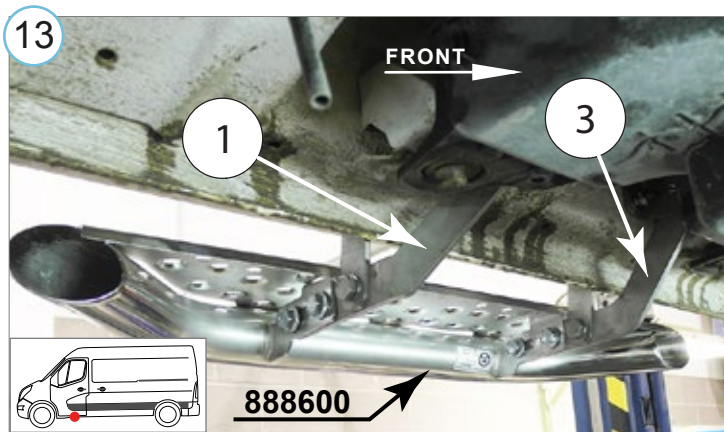
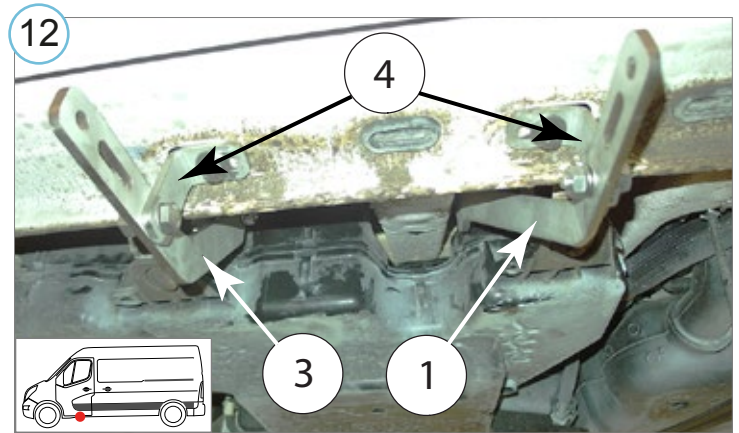
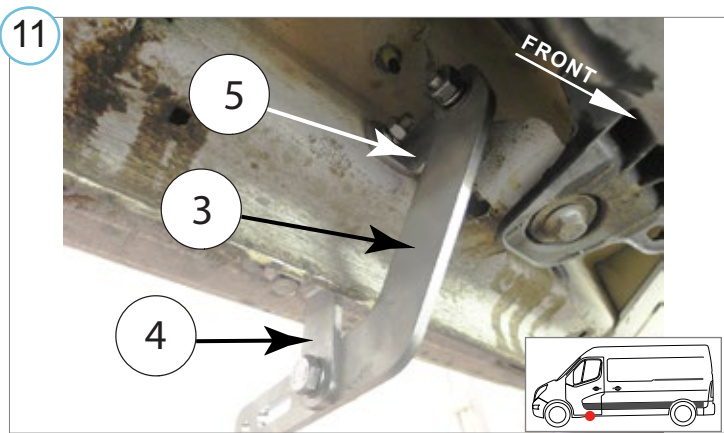
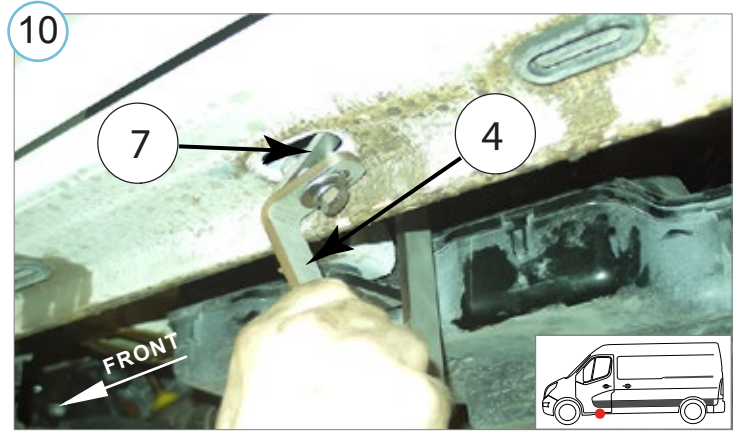
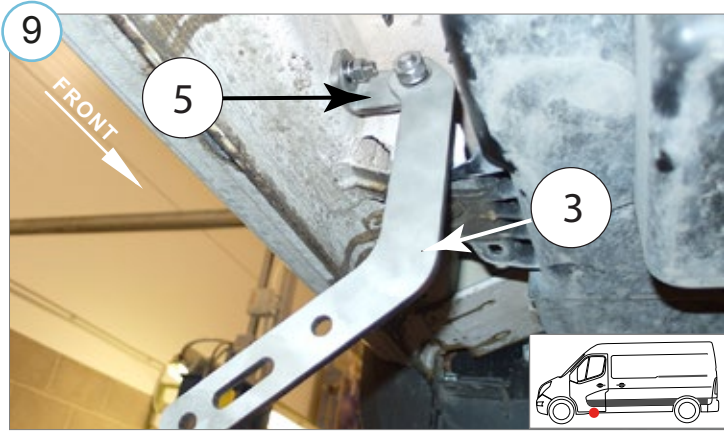

VW Crafter 2017-

Astmelaua VAN TOUR montaažikomplekt esiuksle | Running boards VAN TOUR for the front door, mounting kit | Боковые пороги VAN TOUR для передней двери, монтажный комплект | Trittbretter VAN TOUR für Vordertür

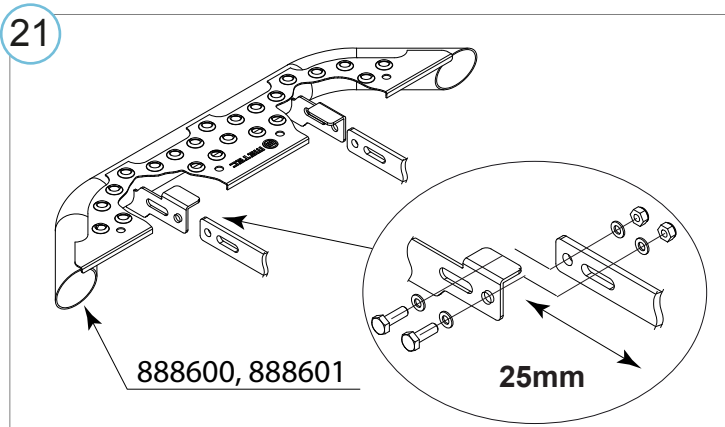
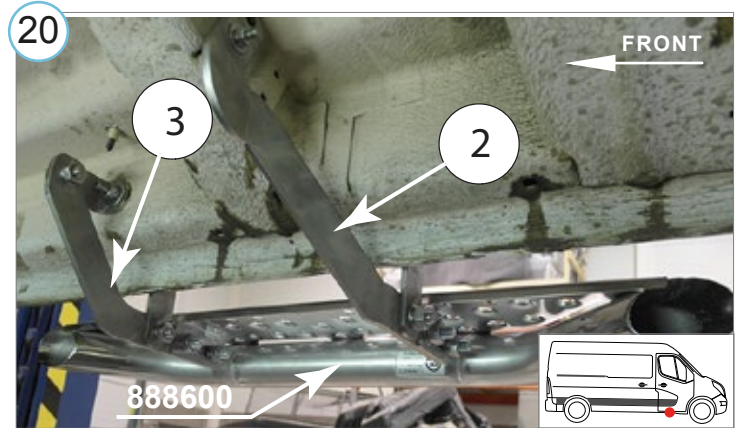
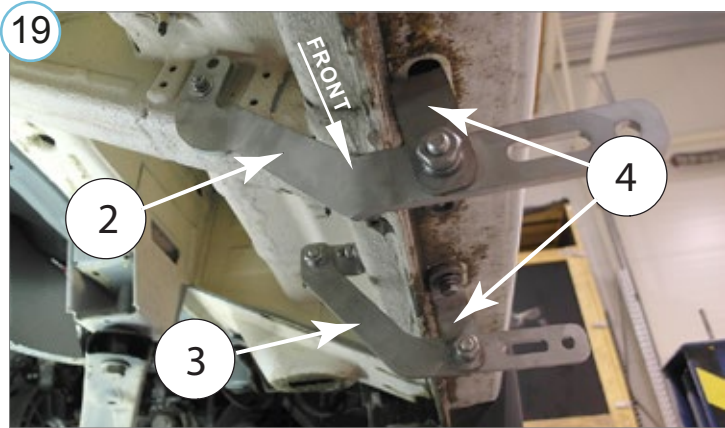
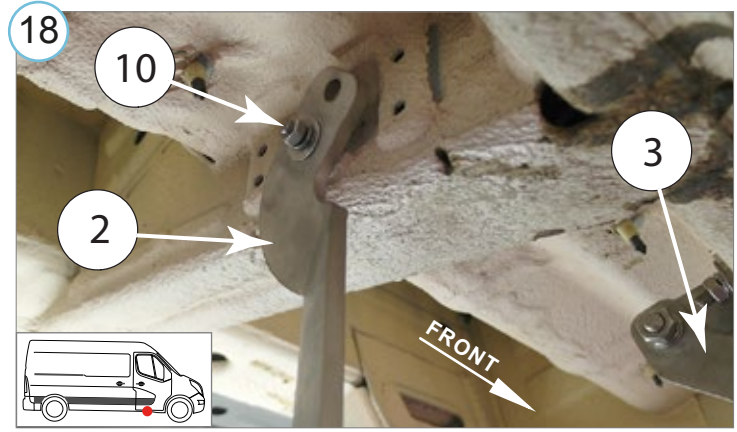
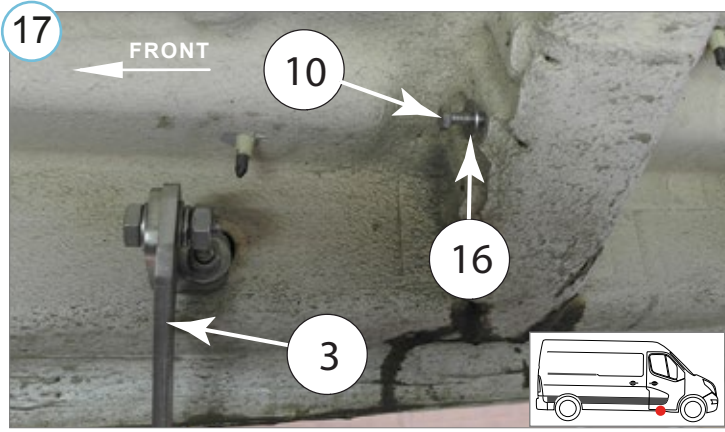

- Kui METEC toode ei vasta Teie ootustele või kui on tegemist toote ebapiisava kvaliteediga, siis pretensioonid esitada lehel www.metec.ee
- If the METEC product does not meet Your expectations or if it is a product of insufficient quality, then you can submit a claim at www.metec.ee
- Если METEC продукт не соответствует Вашим ожиданиям или это продукт недостаточного качества, то претензию предъявить можно на сайте www.metec.ee
- Wenn METEC Produkt nicht Ihren Erwartungen entspricht oder wenn es um Qualitätsmängel geht, dann bitte die Ansprüche auf Seite www.metec.ee einreichen